

Report ID: 393227
Date of sample receipt: 04/06/25
Date of issue: 23/06/25

ISILPLAST PLASTIK SAN. VE TIC. A.S. (SIESTA EXCL.)
ULUS MAH. CATALCA YOLU CAD. NO: 597
34537 TEPECIK, BUYUKCEKMECE-ISTANBUL
TR - TURKEY

Sample name: CASABLANCA sunlonger

SAMPLE N° 393227

Overall dimensions: 740 x 1900 x 310 (h) mm

List of test reports:

1. Outdoor furniture - General safety requirements EN 581-1:2017
2. Loungers: seat and back static load test - reclining back rest EN 1728:2012+AC:2013
3. Loungers: additional seat and leg rest static load test EN 1728:2012+AC:2013
4. Loungers. Seat and back fatigue test - reclining back rest EN 1728:2012+AC:2013
5. Loungers: additional seat durability test EN 1728:2012+AC:2013
6. Loungers: durability test on back rest mechanism EN 1728:2012+AC:2013
7. Loungers: seat impact test EN 1728:2012+AC:2013
8. Loungers. Lifting test for mobile loungers EN 1728:2012+AC:2013
9. Loungers. Stability EN 581-2:2015+AC:2016



This document is part of a PDF file digitally signed by Paolo Tirelli.

The managing director
Dr. Paolo Tirelli

The sample name and, when relevant, its description, are given by the orderer, and CATAS does not assume responsibility on this matter. This test report relates to the sample submitted for the test and no others. Additions, deletions or alterations are not permitted. This test report must always be reproduced in its entirety. Unless otherwise required by standards and technical specifications or agreed with the customer, any declarations of conformity made by CATAS are based on the comparison between results and reference values, where the confidence intervals of the measures are not taken into account. Unless otherwise stated, sampling is made by the customer; in this case the test results are referred to the sample as received.

SAMPLE N° 393227

Date of issue: 23/06/25
Sample weight: Not determined
Sample name: CASABLANCA sunlonger



Side view



Rear view



Bottom view

The sample name and, when relevant, its description, are given by the orderer, and CATAS does not assume responsibility on this matter. This test report relates to the sample submitted for the test and no others. Additions, deletions or alterations are not permitted. This test report must always be reproduced in its entirety. Unless otherwise required by standards and technical specifications or agreed with the customer, any declarations of conformity made by CATAS are based on the comparison between results and reference values, where the confidence intervals of the measures are not taken into account. Unless otherwise stated, sampling is made by the customer; in this case the test results are referred to the sample as received.

TEST REPORT
393227 / 1

Revision: 0
Date of sample receipt: 04/06/25
Date of test: 06/06/25
Date of issue: 23/06/25



Sample name: CASABLANCA sunlounger

ISILPLAST PLASTIK SAN. VE TIC. A.S. (SIESTA EXCL.)

ULUS MAH. CATALCA YOLU CAD. NO: 597
34537 TEPECIK, BUYUKCEKMECE-ISTANBUL
TR - TURKEY

Outdoor furniture - General safety requirements EN 581-1:2017

5.1 General:

Requirement	Observed	Remarks
Edges of seat, back rest and arm rests rounded and chamfered	Yes	None
All other parts: free from burrs, sharp edges and sharp points.	Yes	None
Movable and adjustable parts designed so that injuries and inadvertent operation are avoided	Yes	None
Any load bearing part of furniture not come loose unintentionally	Yes	None
Lubricated parts are protected	Not present	None

5.2 Tubular components:

Requirement	Observed	Remarks
Absence of tubular components with diameter > 7 mm and < 12 mm with a depth > 10 mm.	Yes	None
Tubulars in contact with the floor are closed. Holes in them are allowed as long as they are < 7 mm or > 12 mm	Yes	None

5.3 Shear and squeeze points:

Requirement	Observed	Remarks
Shear and squeeze points that are created only during adjusting and folding away are acceptable if the user has the control of his/her movements.	Yes	None
Absence of shear and squeeze points, created by parts operated by powered mechanism.	Not applicable	None
Absence of shear and squeeze points, created by loads applied during normal use.	Yes	None

Conformity to requirements of clause 5 of standard EN 581-1:2017:	YES
---	------------

This test report is part of a PDF file digitally signed by Paolo Tirelli.

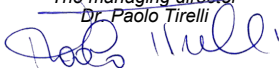
The managing director
Dr. Paolo Tirelli

The sample name and, when relevant, its description, are given by the orderer, and CATAS does not assume responsibility on this matter. This test report relates to the sample submitted for the test and no others. Additions, deletions or alterations are not permitted. This test report must always be reproduced in its entirety. Unless otherwise required by standards and technical specifications or agreed with the customer, any declarations of conformity made by CATAS are based on the comparison between results and reference values, where the confidence intervals of the measures are not taken into account. Unless otherwise stated, sampling is made by the customer; in this case the test results are referred to the sample as received.

TEST REPORT
393227 / 2

Revision: 0
 Date of sample receipt: 04/06/25
 Date of test: 06/06/25
 Date of issue: 23/06/25



Sample name: CASABLANCA sunlounger

ISILPLAST PLASTIK SAN. VE TIC. A.S. (SIESTA EXCL.)
 ULUS MAH. CATALCA YOLU CAD. NO: 597
 34537 TEPECIK, BUYUKCEKMECE-ISTANBUL
 TR - TURKEY

Loungers: seat and back static load test - reclining back rest EN 1728:2012+AC:2013

Test performed according to the test method EN 1728:2012+AC:2013, clause 8.2 and in accordance to the test parameters of EN 581-2:2015+AC:2016, table 1

Back rest inclination: 29 °

Test results:

Seat force N	Back force N	Back rest position	Time of application	Number of cycles	Remarks
2.000	560	Vertical	10 s	5	No defects
1.500	1.310	Reclined	10 s	5	No defects
1.500	1.310	Reclined	30 min	1	No defects

The test results comply with the requirements in clause 6.2.2 of standard EN 581-2:2015+AC:2016, contract level

This test report is part of a PDF file digitally signed by Paolo Tirelli.

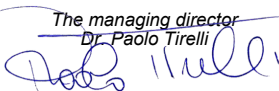
The managing director
 Dr. Paolo Tirelli

The sample name and, when relevant, its description, are given by the orderer, and CATAS does not assume responsibility on this matter. This test report relates to the sample submitted for the test and no others. Additions, deletions or alterations are not permitted. This test report must always be reproduced in its entirety. Unless otherwise required by standards and technical specifications or agreed with the customer, any declarations of conformity made by CATAS are based on the comparison between results and reference values, where the confidence intervals of the measures are not taken into account. Unless otherwise stated, sampling is made by the customer; in this case the test results are referred to the sample as received.

TEST REPORT

393227 / 3

Revision: 0
Date of sample receipt: 04/06/25
Date of test: 06/06/25
Date of issue: 23/06/25



Sample name: CASABLANCA sunlounger

ISILPLAST PLASTIK SAN. VE TIC. A.S. (SIESTA EXCL.)

ULUS MAH. CATALCA YOLU CAD. NO: 597
34537 TEPECIK, BUYUKCEKMECE-ISTANBUL
TR - TURKEY

Loungers: additional seat and leg rest static load test EN 1728:2012+AC:2013

Test performed according to the test method EN 1728:2012+AC:2013, clause 8.3 and in accordance to the test parameters of EN 581-2:2015+AC:2016, table 1

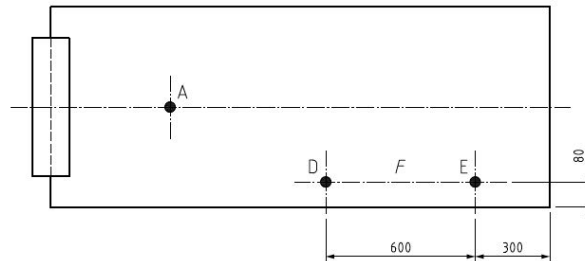
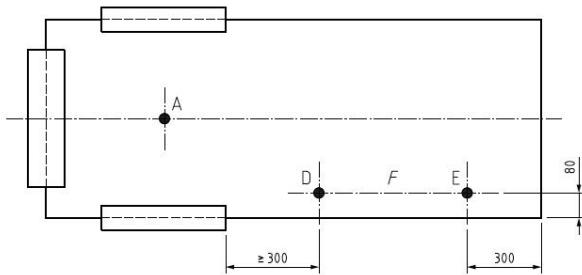

Force on point A N	Force between point D and E N	Number of cycles	Time of application	Remarks
750	900	10	10 s	No defects
750	900	1	30 min	No defects

The test results comply with the requirements in clause 6.2.2 of standard EN 581-2:2015+AC:2016, contract level

This test report is part of a PDF file digitally signed by Paolo Tirelli.

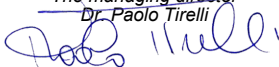
The managing director
Dr. Paolo Tirelli

The sample name and, when relevant, its description, are given by the orderer, and CATAS does not assume responsibility on this matter. This test report relates to the sample submitted for the test and no others. Additions, deletions or alterations are not permitted. This test report must always be reproduced in its entirety. Unless otherwise required by standards and technical specifications or agreed with the customer, any declarations of conformity made by CATAS are based on the comparison between results and reference values, where the confidence intervals of the measures are not taken into account. Unless otherwise stated, sampling is made by the customer; in this case the test results are referred to the sample as received.

TEST REPORT
393227 / 4

Revision: 0
 Date of sample receipt: 04/06/25
 Date of test: 06/06/25
 Date of issue: 23/06/25



Sample name: CASABLANCA sunlounger

ISILPLAST PLASTIK SAN. VE TIC. A.S. (SIESTA EXCL.)
 ULUS MAH. CATALCA YOLU CAD. NO: 597
 34537 TEPECIK, BUYUKCEKMECE-ISTANBUL
 TR - TURKEY

Loungers. Seat and back fatigue test - reclining back rest EN 1728:2012+AC:2013

Test performed according to the test method EN 1728:2012+AC:2013, clause 8.4.1 and in accordance to the test parameters of EN 581-2:2015+AC:2016, table 1

Back rest inclination: 29 °

Test results:

Seat forceN	Back forceN	Back rest position	Number of cycles	Remarks
1.000	333	Vertical	25.000	No defects
750	660	Reclined	25.000	No defects

Total cycles carried out: 50.000

The test results comply with the requirements in clause 6.2.2 of standard EN 581-2:2015+AC:2016, contract level

This test report is part of a PDF file digitally signed by Paolo Tirelli.

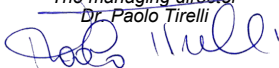
The managing director
 Dr. Paolo Tirelli

The sample name and, when relevant, its description, are given by the orderer, and CATAS does not assume responsibility on this matter. This test report relates to the sample submitted for the test and no others. Additions, deletions or alterations are not permitted. This test report must always be reproduced in its entirety. Unless otherwise required by standards and technical specifications or agreed with the customer, any declarations of conformity made by CATAS are based on the comparison between results and reference values, where the confidence intervals of the measures are not taken into account. Unless otherwise stated, sampling is made by the customer; in this case the test results are referred to the sample as received.

TEST REPORT
393227 / 5

Revision: 0
 Date of sample receipt: 04/06/25
 Date of test: 16/06/25
 Date of issue: 23/06/25



Sample name: CASABLANCA sunlounger

ISILPLAST PLASTIK SAN. VE TIC. A.S. (SIESTA EXCL.)
 ULUS MAH. CATALCA YOLU CAD. NO: 597
 34537 TEPECIK, BUYUKCEKMECE-ISTANBUL
 TR - TURKEY

Loungers: additional seat durability test EN 1728:2012+AC:2013

Test performed according to the test method EN 1728:2012+AC:2013, clause 8.4.2 and in accordance to the test parameters of EN 581-2:2015+AC:2016, table 1

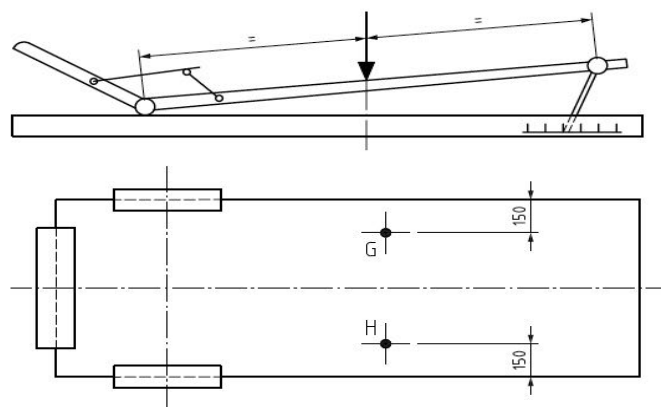
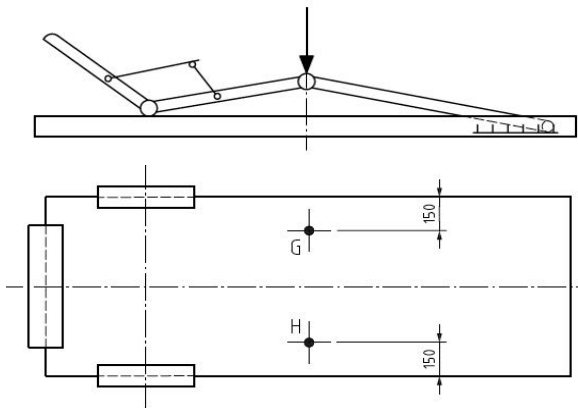

Test results:

Vertical force in points G and H N	Number of cycles per point	Remarks
1.000	20.000	No defects

The test results comply with the requirements in clause 6.2.2 of standard EN 581-2:2015+AC:2016, contract level

This test report is part of a PDF file digitally signed by Paolo Tirelli.

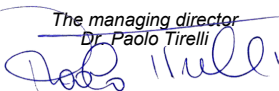
The managing director
 Dr. Paolo Tirelli

The sample name and, when relevant, its description, are given by the orderer, and CATAS does not assume responsibility on this matter. This test report relates to the sample submitted for the test and no others. Additions, deletions or alterations are not permitted. This test report must always be reproduced in its entirety. Unless otherwise required by standards and technical specifications or agreed with the customer, any declarations of conformity made by CATAS are based on the comparison between results and reference values, where the confidence intervals of the measures are not taken into account. Unless otherwise stated, sampling is made by the customer; in this case the test results are referred to the sample as received.

TEST REPORT
393227 / 6

Revision: 0
 Date of sample receipt: 04/06/25
 Date of test: 17/06/25
 Date of issue: 23/06/25



Sample name: CASABLANCA sunlounger

ISILPLAST PLASTIK SAN. VE TIC. A.S. (SIESTA EXCL.)
 ULUS MAH. CATALCA YOLU CAD. NO: 597
 34537 TEPECIK, BUYUKCEKMECE-ISTANBUL
 TR - TURKEY

Loungers: durability test on back rest mechanism EN 1728:2012+AC:2013

Test performed according to the test method EN 1728:2012+AC:2013, clause 8.2 and in accordance to the test parameters of EN 581-2:2015+AC:2016, table 1

Test results:

Mass on the seat kg	Back force N	Number of cycles	Remarks
100	250	20.000	No defects

The test results comply with the requirements in clause 6.2.2 of standard EN 581-2:2015+AC:2016, contract level

This test report is part of a PDF file digitally signed by Paolo Tirelli.

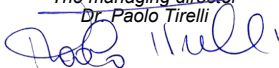
The managing director
 Dr. Paolo Tirelli

The sample name and, when relevant, its description, are given by the orderer, and CATAS does not assume responsibility on this matter. This test report relates to the sample submitted for the test and no others. Additions, deletions or alterations are not permitted. This test report must always be reproduced in its entirety. Unless otherwise required by standards and technical specifications or agreed with the customer, any declarations of conformity made by CATAS are based on the comparison between results and reference values, where the confidence intervals of the measures are not taken into account. Unless otherwise stated, sampling is made by the customer; in this case the test results are referred to the sample as received.

TEST REPORT
393227 / 7

Revision: 0
 Date of sample receipt: 04/06/25
 Date of test: 19/06/25
 Date of issue: 23/06/25



Sample name: CASABLANCA sunlounger

ISILPLAST PLASTIK SAN. VE TIC. A.S. (SIESTA EXCL.)
 ULUS MAH. CATALCA YOLU CAD. NO: 597
 34537 TEPECIK, BUYUKCEKMECE-ISTANBUL
 TR - TURKEY

Loungers: seat impact test EN 1728:2012+AC:2013

Test performed according to the test method EN 1728:2012+AC:2013, clause 8.8 and in accordance to the test parameters of EN 581-2:2015+AC:2016, table 1

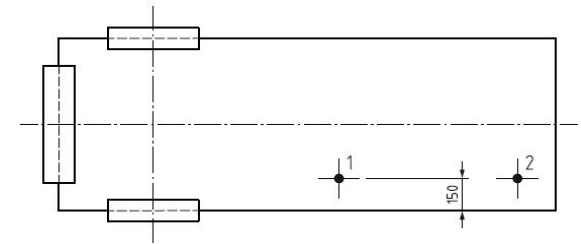
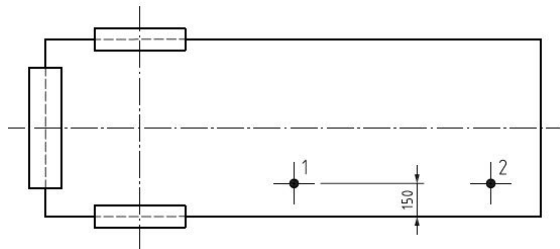
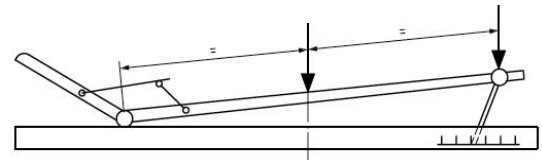
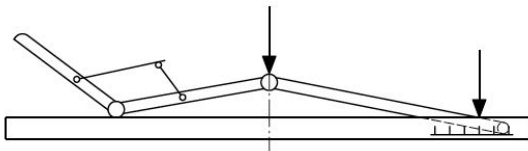

Test results:

Mass of impactor kg	Height of drop mm	Number of cycles	Impact point	Remarks
25	240	10	Point 1	No defects
25	240	10	Point 2	No defects
25	240	10	seat loading point (A)	No defects

The test results comply with the requirements in clause 6.2.2 of standard EN 581-2:2015+AC:2016, contract level

This test report is part of a PDF file digitally signed by Paolo Tirelli.

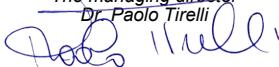
The managing director
 Dr. Paolo Tirelli

The sample name and, when relevant, its description, are given by the orderer, and CATAS does not assume responsibility on this matter. This test report relates to the sample submitted for the test and no others. Additions, deletions or alterations are not permitted. This test report must always be reproduced in its entirety. Unless otherwise required by standards and technical specifications or agreed with the customer, any declarations of conformity made by CATAS are based on the comparison between results and reference values, where the confidence intervals of the measures are not taken into account. Unless otherwise stated, sampling is made by the customer; in this case the test results are referred to the sample as received.

TEST REPORT
393227 / 8

Revision: 0
 Date of sample receipt: 04/06/25
 Date of test: 19/06/25
 Date of issue: 23/06/25



Sample name: CASABLANCA sunlounger

ISILPLAST PLASTIK SAN. VE TIC. A.S. (SIESTA EXCL.)
 ULUS MAH. CATALCA YOLU CAD. NO: 597
 34537 TEPECİK, BUYUKCEKMECE-ISTANBUL
 TR - TURKEY

Loungers. Lifting test for mobile loungers EN 1728:2012+AC:2013

Test performed according to the test method EN 1728:2012+AC:2013, clause 8.8 and in accordance to the test parameters of EN 581-2:2015+AC:2016, table 1

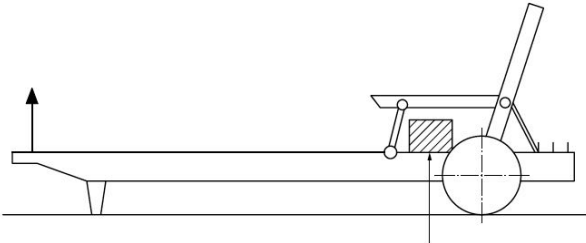

Test results:

Mass on the seat kg	Number of lifting cycles	Remarks
100	2.000	No defects

The test results comply with the requirements in clause 6.2.2 of standard EN 581-2:2015+AC:2016, contract level

This test report is part of a PDF file digitally signed by Paolo Tirelli.

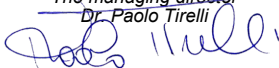
The managing director
 Dr. Paolo Tirelli

The sample name and, when relevant, its description, are given by the orderer, and CATAS does not assume responsibility on this matter. This test report relates to the sample submitted for the test and no others. Additions, deletions or alterations are not permitted. This test report must always be reproduced in its entirety. Unless otherwise required by standards and technical specifications or agreed with the customer, any declarations of conformity made by CATAS are based on the comparison between results and reference values, where the confidence intervals of the measures are not taken into account. Unless otherwise stated, sampling is made by the customer; in this case the test results are referred to the sample as received.

TEST REPORT
393227 / 9

Revision: 0
Date of sample receipt: 04/06/25
Date of test: 19/06/25
Date of issue: 23/06/25



Sample name: CASABLANCA sunlounger

ISILPLAST PLASTIK SAN. VE TIC. A.S. (SIESTA EXCL.)
ULUS MAH. CATALCA YOLU CAD. NO: 597
34537 TEPECIK, BUYUKCEKMECE-ISTANBUL
TR - TURKEY

Loungers. Stability EN 581-2:2015+AC:2016

Stability EN 581-2:2015+AC:2016, annex A

Sideways stability, annex A, clause A.1.1

Loungers with arm rests:

Force in F_{B1}: 600 N
Force in F_{B2}: 250 N
Time of application: 5 sec

Remarks:

/

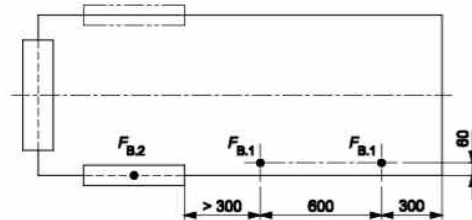

Loungers without arm rests:

Force in F_{B1}: 600 N
Time of application: 5 sec

Remarks:

The lounger does not overbalance

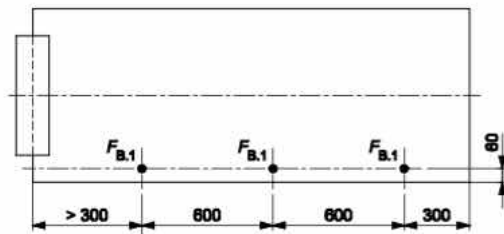

Forward stability, annex A, clause A.1.2

Force in F_{B3}: 600 N
Time of application: 5 sec

Remarks:

The lounger does not overbalance

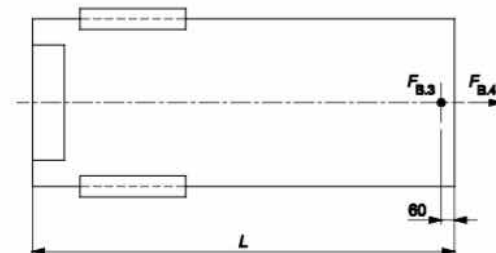

This test report is part of a PDF file digitally signed by Paolo Tirelli.

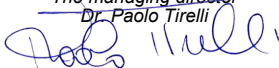
The managing director
Dr. Paolo Tirelli

The sample name and, when relevant, its description, are given by the orderer, and CATAS does not assume responsibility on this matter. This test report relates to the sample submitted for the test and no others. Additions, deletions or alterations are not permitted. This test report must always be reproduced in its entirety. Unless otherwise required by standards and technical specifications or agreed with the customer, any declarations of conformity made by CATAS are based on the comparison between results and reference values, where the confidence intervals of the measures are not taken into account. Unless otherwise stated, sampling is made by the customer; in this case the test results are referred to the sample as received.

TEST REPORT

393227 / 9 rev. 0

Date of issue:

23/06/25

Sample name:

CASABLANCA sunlonger

Rearwards stability, EN 1022:2005

Fixed back chair, clause 6.6

Horizontal force : 215 N does not overturn

Chair with back rest inclination, clause 7.5

Loading discs on the seat : 3

Loading discs on the back : 8 does not overturn

Remarks:

The lounge does not overbalance

This test report is part of a PDF file digitally signed by Paolo Tirelli.

The managing director
Dr. Paolo Tirelli
